

Let's Make Recycled Handmade Paper

The tools and materials that you will need to make your handmade paper:

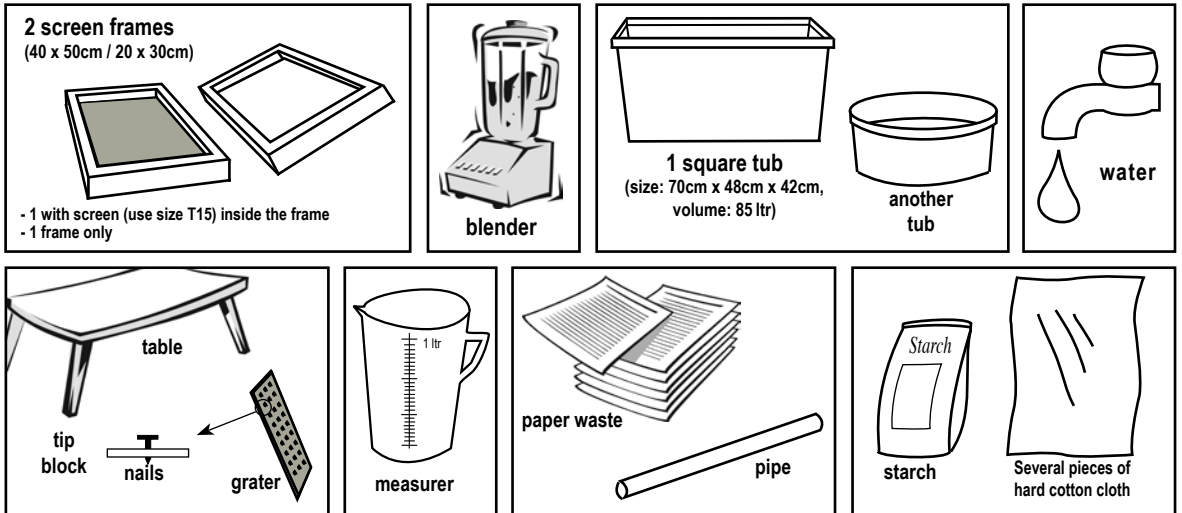

1. Put 1 kg of waste paper (white paper only) in a tub, add water, and soak for 12-24 hours.

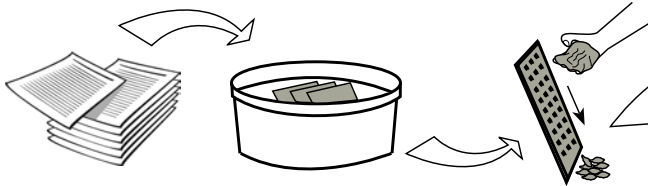

2. Grate all the paper, place one handful of grated paper in the blender and fill with water. Blend until it becomes a porridge like pulp. Place the paper pulp into the tub.

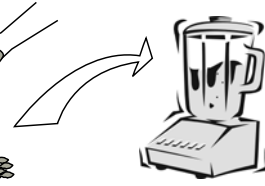

3. Boil 2 ltr of water. Add 150 gr of starch to 300 ml of water. Combine the starch mix and boiled (warm) water.

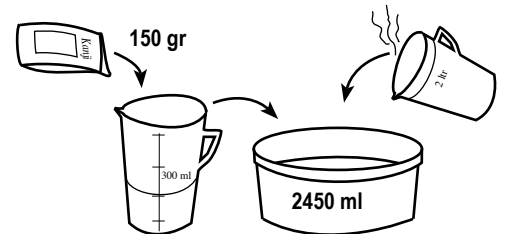

4. Pour 30 ltr of water into the square tub and add 500 ml of starch water. Combine the rest of the starch water (950 ml) with the paper pulp, then mix.

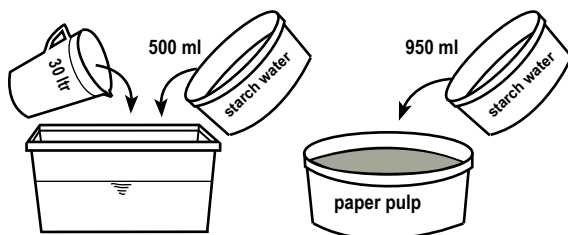

5. Pour 2 ltr of paper pulp into square tub and mix well. Place 1 sheet of hard cotton cloth on the table.

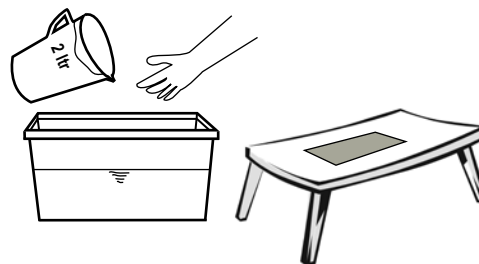

6. Assemble the 2 screen frames, like the picture below. The screen must be in the middle of the two frames.

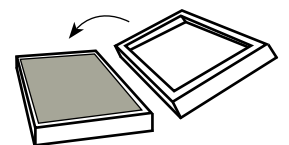

7. Place the screen in the square tub, then drain off as much water as you can.

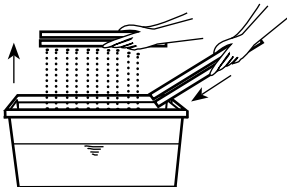

8. Lift the frame without the screen, there will be a sheet of paper pulp on the screen below. Place the paper pulp onto the cloth, scrape the screen with the pipe (same width with as the screen) to remove excess water, then turn the screen over onto the cloth.

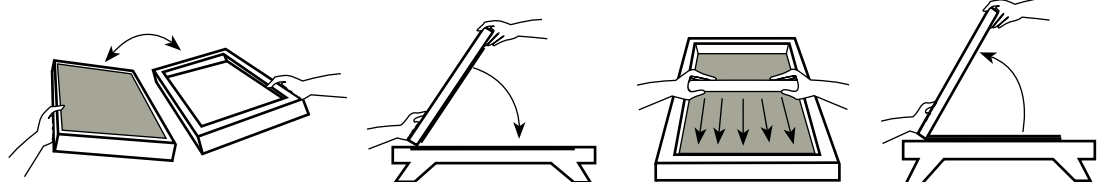

9. Place another piece of cloth on top and repeat steps 6-8 until you have 8 sheets of recycled paper.

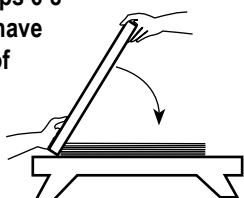

10. To make more than 8 sheets of paper, pour 1 ltr of paper pulp into the square tub and repeat steps 6-10.



11. Pick up the cloth-paper layers one by one and hang them in a shady place for 6-8 hours. When they are half dry, place them in direct sunlight until completely dry.

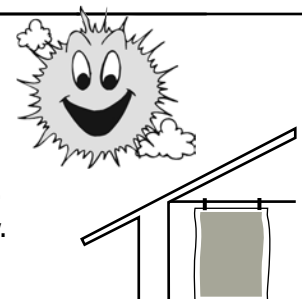

Smart Ideas

1. Applique technique

Place some small flowers, leaves, or grass onto a sheet of wet paper and cloth. Soak them for around 1-2 hours before applying. If they are quite thick, boil them for 1-2 hours before applying.

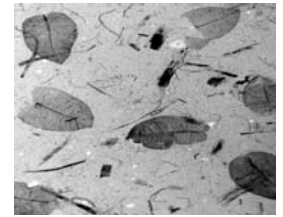
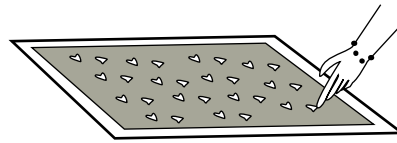

2. Mixing technique

While you are blending the pulp in the blender, throw in some natural materials that will add color or texture.

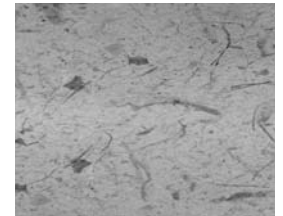

Here are some ideas of things you can make with your recycled handmade paper...

- Paper for drawings and craft projects.
- Paper to wrap presents, books, or jars.
- Cards, invitations, envelopes, or folders.
- Pencil holders.
- Photo frames.
- Gift boxes.
- Lamp shades.



Some natural materials you can use to give color to your paper...

If you want to make paper with special colors, try adding these liquids into the paper pulp. Some of these colors are very strong, so use rubber gloves for this project.

For natural coloring, use:

- Turmeric – when boiled and sieved it depletes YELLOW color.
- Teak wood leaf – when boiled and sieved it depletes RED color.
- Pandanus amaryllifolius leaf (*pandan wangi*) – when boiled and sieved it depletes GREEN color.
- Uncaria gambir (*gambir*) – when boiled and sieved it depletes BLACK color.
- Aglaia odorata lour (*pacar cina*) – when boiled and sieved it depletes PINK color.
- Indigofera tinctoria L (*nila*) – when boiled and sieved it depletes BLUE color.

